

Installers &
User guide
Deadbolt 2S
Metal Grey.

Hi there!

We're so glad you've decided to join us on this journey to create a world without keys. You're officially an igloohomie!

In this guide, you'll find everything you need to get started with your lock. We hope that we've been as comprehensive and informative as possible. Afterall, we're here to make life easier for you (at least when it comes to your home's access).

If you do not find what you're looking for, we're working on updating it. Or... you could reach out to us at support@igloohome.co because we love interacting with you! Speaking of interaction, let's stay connected regardless. Why don't you join the community of igloohomies worldwide?



Follow us on
Facebook



Watch us on
YouTube



Or stalk us on
Instagram



Maybe network with
us on LinkedIn



We're always updating our guides because we want to keep things fresh! You can visit igloohome.co/support periodically to view the latest version, unless, this is the latest version. Hello you, igloohomie from the future, wow!

Table of Contents

What's Included	4
Specifications	5
Installation Guide	
Requirements	6
Prepare Door for Installation	7
Prepare Lock for Installation	9
Installation Instructions	10
Test Lock	16
Prepare the Door Frame	17
User Guide	
Lock Anatomy	18
Features	19
Modes of Access	21
App Onboarding	23
Managing Access via the app	26
Manage Ecosystem Products via the app	28
Manage Lock Features	31
Manage Lock Settings	33
View Activity Logs	34
Emergency Jumpstart	35
Physical Key	36
Connect with Airbnb	37
Audio and LED Indications	38
Intergrations	39
Troubleshooting	40

What's Included



**Front Assembly
& Rubber Gasket**

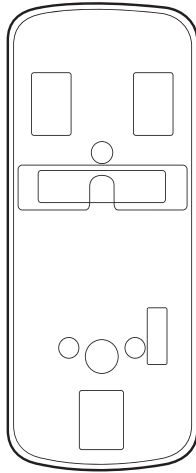

**Back Assembly
Rubber Gasket**

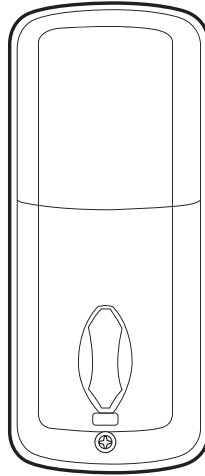

Back Assembly

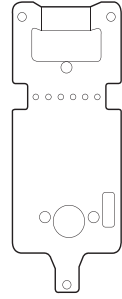

Back Plate

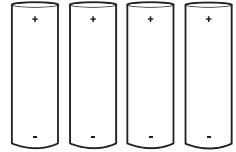

AA Alkaline Batteries x4

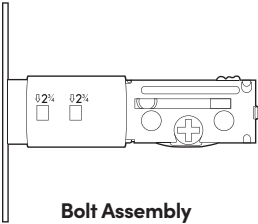

Bolt Assembly

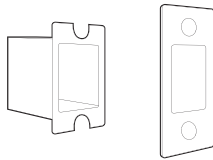

**Strike Plate Housing &
Strike Plate**



Screw Holder

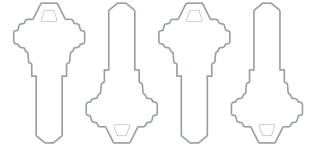

Keys x4



**5mm (0.019")
Bolt Screw x2**



**8mm (0.03")
Bolt Screw x2**

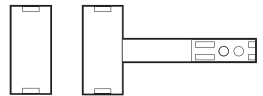

Door Sensor & Magnet

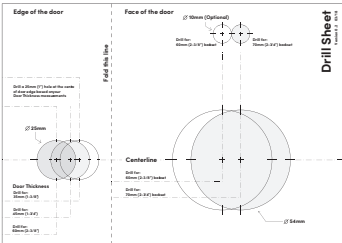

Drill Sheet

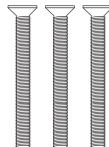

**43mm (1.69")
Bolt Screw x3**

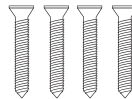

**22mm (0.87")
Wood Screw x4**



**20mm (0.78")
Bolt Screw**



**Keyhole
Cover x1**

Specifications

Model	IGB4
Weight	Net: 1.2kg, Gross: 1.6kg
Body	Zinc Alloy, ABS, Acrylic
Modes of Access (Entry)	PIN codes, Bluetooth keys, Mechanical keys
Modes of Access (Exit)	Thumbturn
Power Type	4 AA alkaline batteries
Battery Life	Up to 10 months
Emergency Power	9V Alkaline Battery
Battery Operating Temp.	-20°C to 54°C / -4°F to 129°
Operation Temp.	-25°C to 50°C / -13°F to 122°F
Certifications	IP65, CE, FCC, Giteki, ANSI Grade 2
Protocols	Bluetooth 4.2, algoPIN™ technology
Usage	Advised to be installed under sheltered areas, not to be exposed to wet weather conditions.

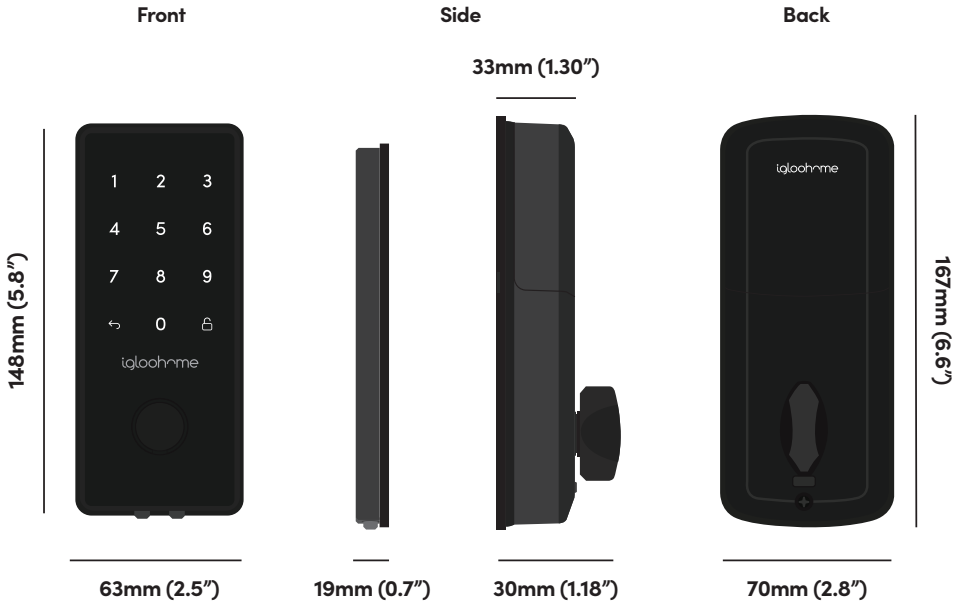

* **DO NOT USE:** Heavy Duty, Eveready, GP, or rechargeable batteries. Please note that using recommended battery brands such as Panasonic, Duracell, or Energizer will improve the performance and lifespan of the lock.

Installation Guide

Requirements

Door Thickness

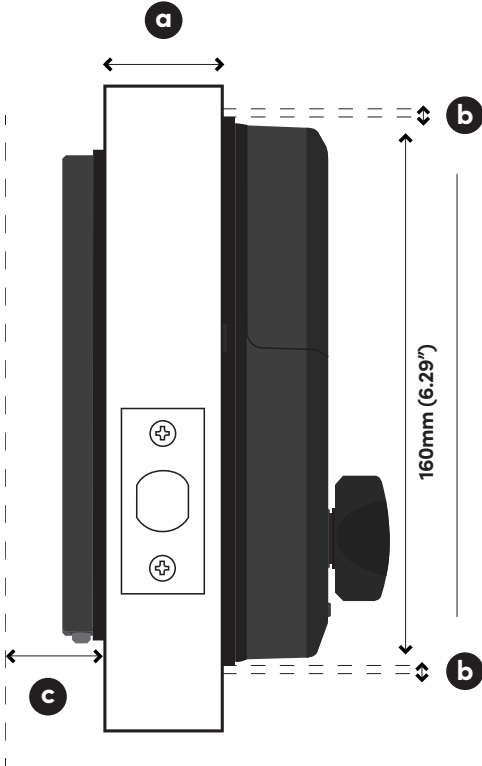

Clearance

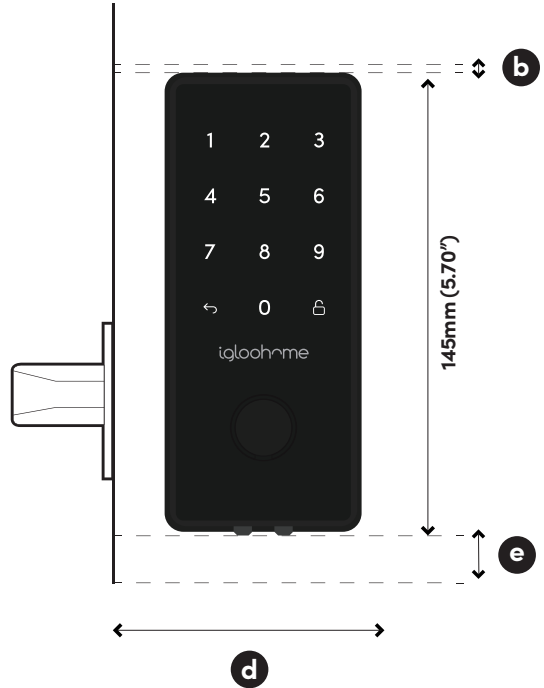

Measurements

- a** 35mm (1.37") to 60mm (2.36")
- b** 10mm (0.39")
- c** 20mm (0.78")
- d** >110mm (4.33") for 60mm (2.36") / >120mm (4.72") for 70mm (2.75") backset
- e** 50mm (1.96")

Prepare Door for Installation

Items needed:

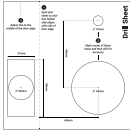

Drill Sheet



Drill

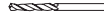

10mm (0.39")
Drill Bit



54mm (2.12")
Hole Saw

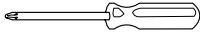

#2 Phillips Screw Driver



25mm (0.98")
Spade Bit

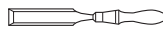

20mm (0.78")
Chisel



Hammer

Recommended

Door and door frame material : **Wood**



Recommended

Gap between door and door frame: **<3mm (0.01")**

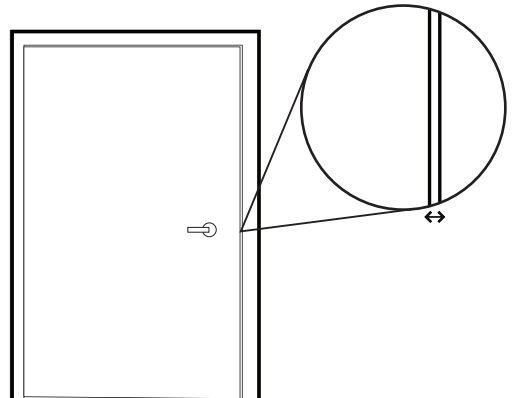

Please ensure that there is an existing handle on your door for push - pull access.

Not for: metal gates, glass doors or sliding doors.

If you are unsure if your door is suitable, send us web links to your door pictures to info@igloohome.co

How to use the Drill Sheet

Drilling (Door)

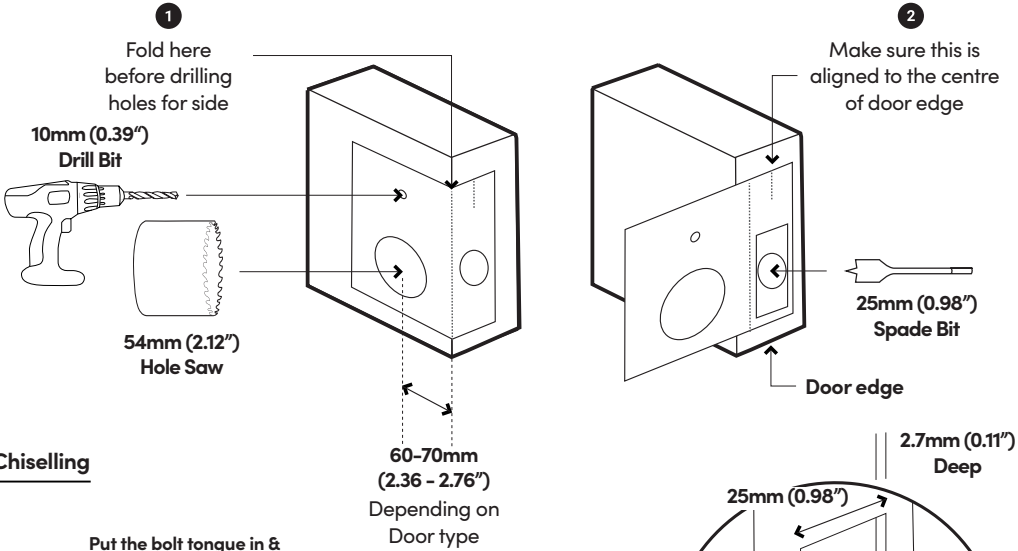

Chiselling

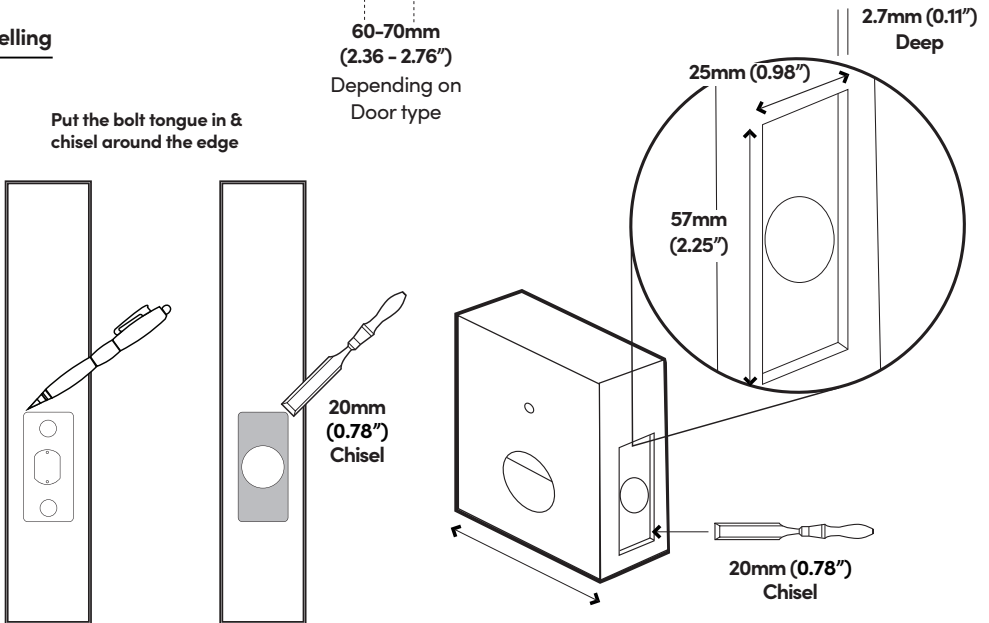

 Mark the center of the holes and then drill for accuracy.

Prepare Lock For Installation

1 Set Back Assembly for Left / Right Hand Installation

Left Hand Installation

Set the toggle to 'LH' for left-hand installation

** Hinge is on your left.*

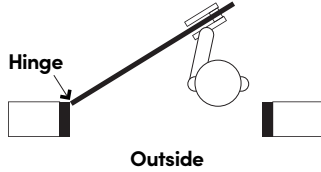

Right Hand Installation

Set the toggle to 'RH' for right-hand installation

** Hinge is on your right.*

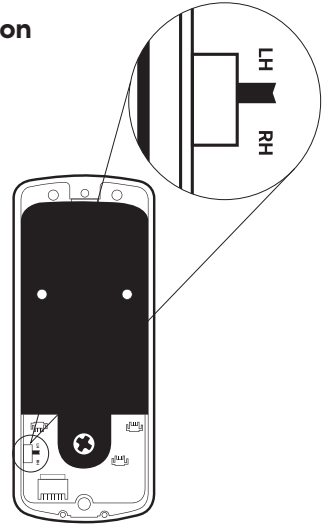
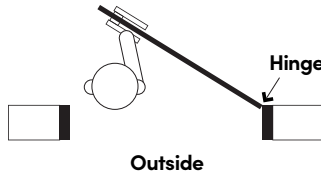

Note: If your BT ID is greater than IGB412 please skip this step, Left/Right Hand installation will be configured in the App.

2 Remove Battery Cover from the Back Assembly

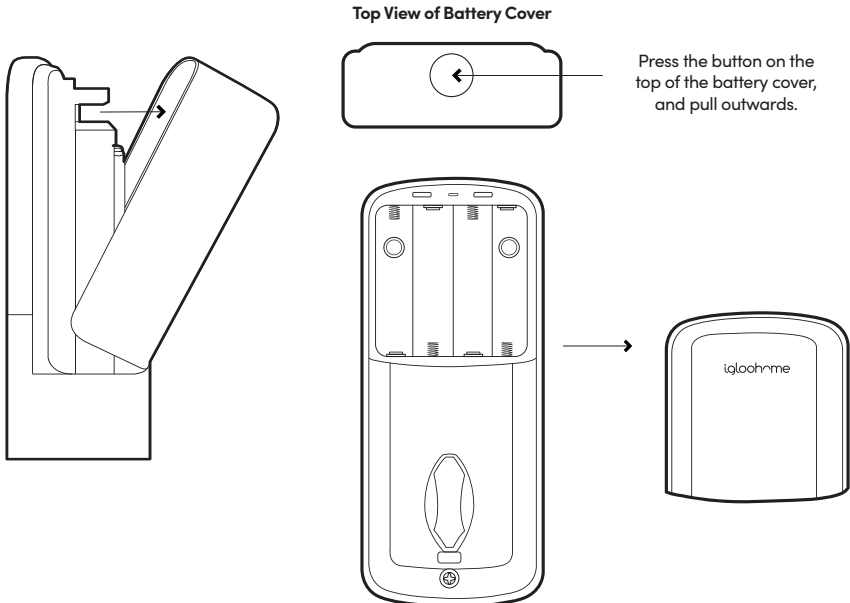

Installation Instructions

1 Measure

If you are replacing your current deadbolt lock, industry standards are 60mm (2.36") or 70mm (2.75") backset. To determine which backset length you should use, so measure the distance (x) between the center of 54mm (2.12") hole to door edge.

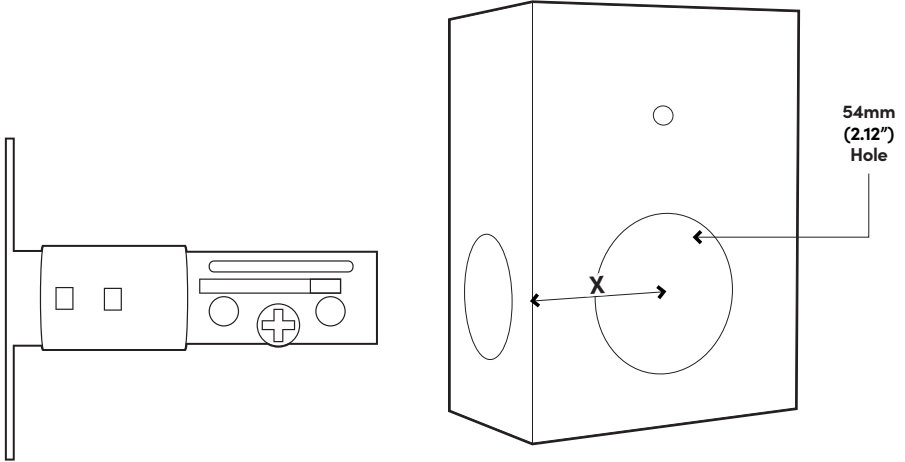

Prepare bolt assembly based on the distance (x)

Bolt ships with bolt assembly in 60mm (2.36") position. If required, twist the bolt and pull to extend (simultaneously) to 70mm (2.75") backset position.

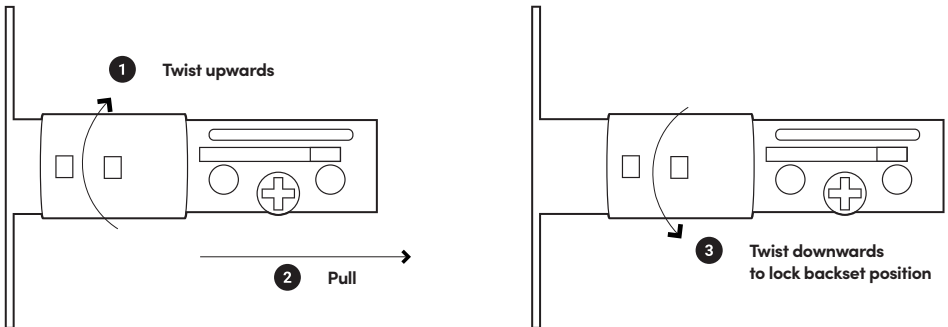

2 Insert bolt and front assembly into door edge

The '+' hole on the backset should be in the middle of the hole.

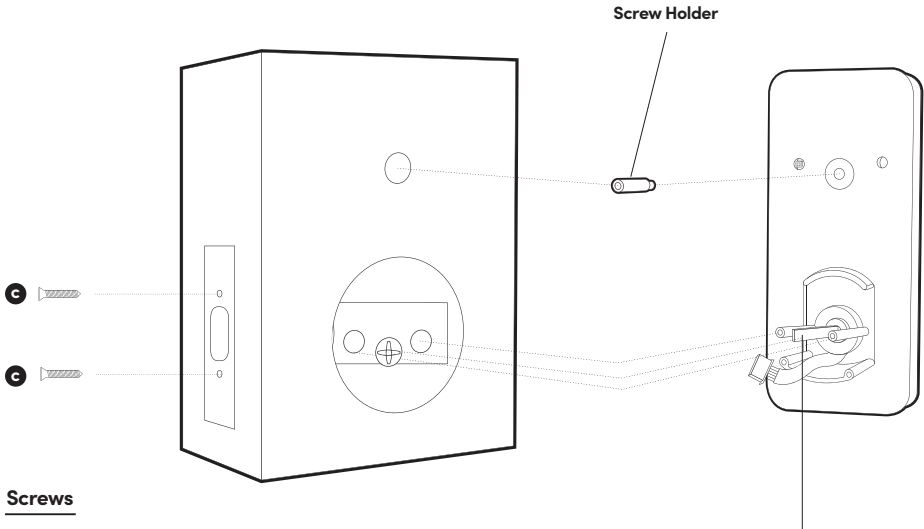

⚠ Please ensure that tailpiece is in vertical position.



3 Measure and cut the tailpiece if necessary

After inserting the tailpiece, measure the distance of protrusion from the door.

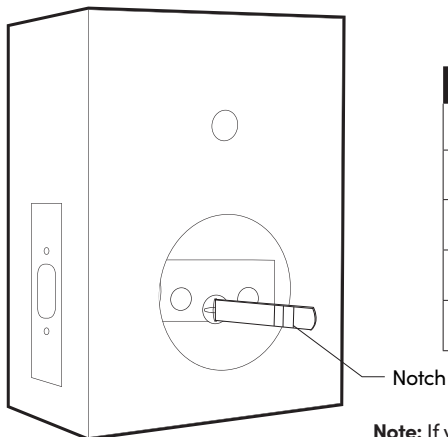

Door thickness (mm)	No. of notch to cut
60	0
55	1
45	2
40	3
35	4

Note: If your BT ID is greater than IGB412 please skip this step, Left/Right Hand installation will be configured in the App.

4 Secure the Front Assembly using the Back Plate.

To do this, place the Back Plate (ensuring the correct side placement).

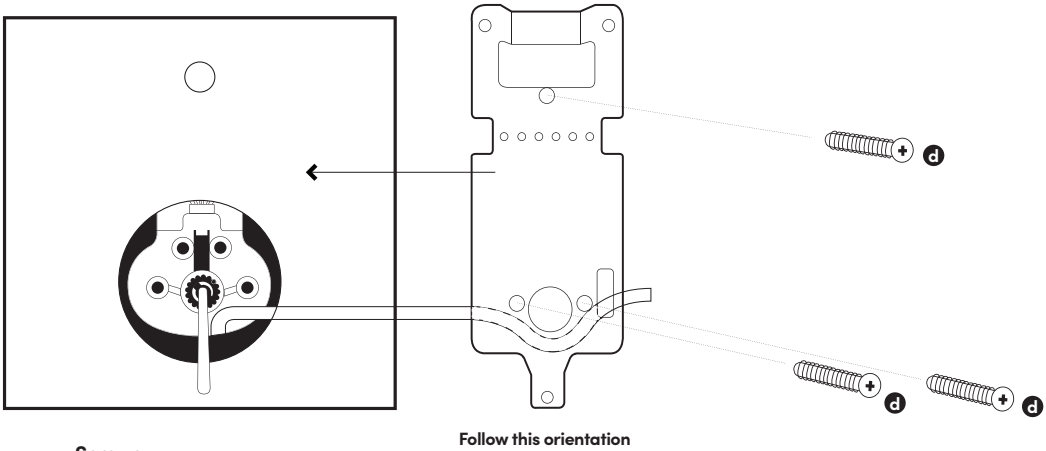

Screws

d 43mm (1.69") 

5 Door Sensor Installation

Adjust the position of the door sensor according to the door handling (left or right hand installation). Use the 2 x 5mm (0.19") screws to secure the door sensor to the back plate.

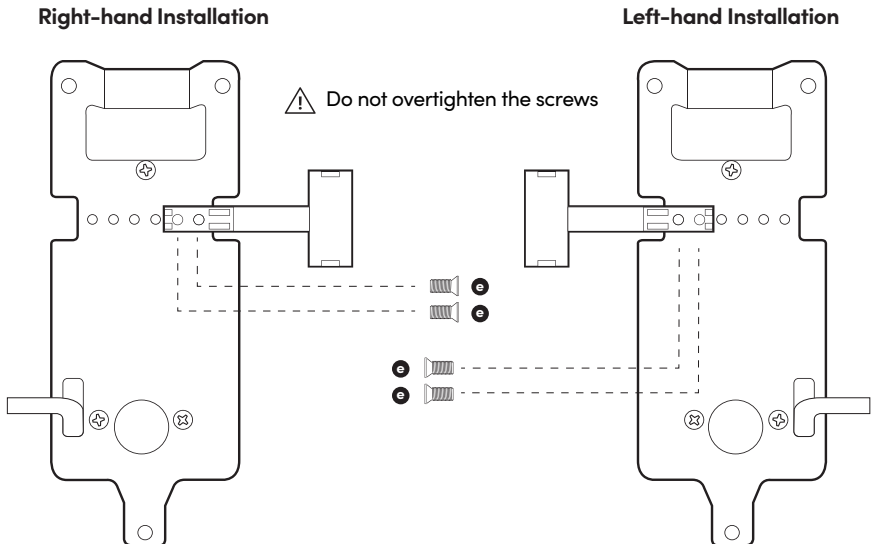

Screws

e 5mm (0.19") 

6 Fit in the Rubber Gasket

Insert the front assembly cable through the rectangular hole on the rubber gasket. The hole should be on the right side of the rubber gasket.

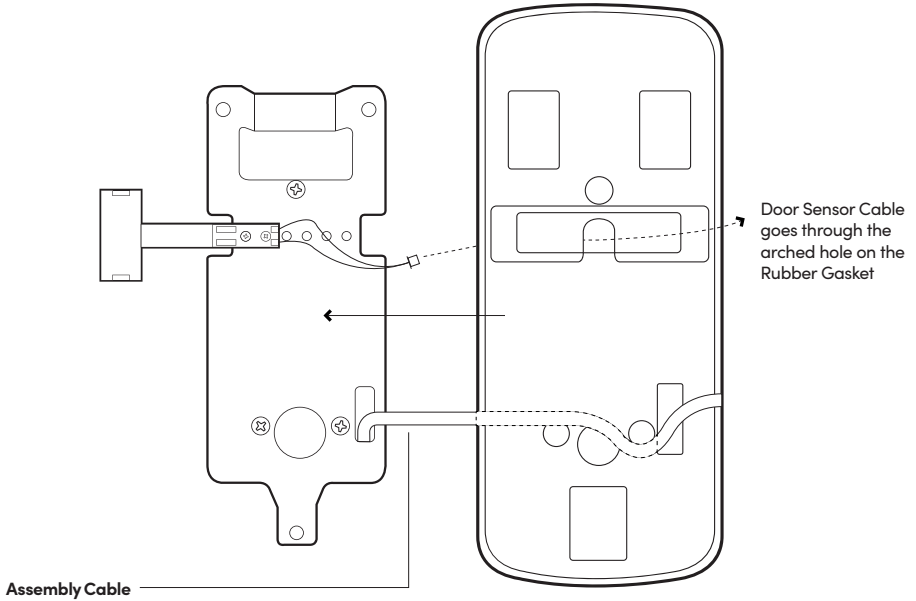

Right-hand Installation

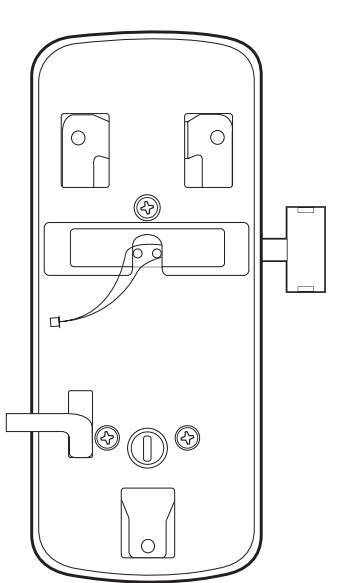

Left-hand Installation

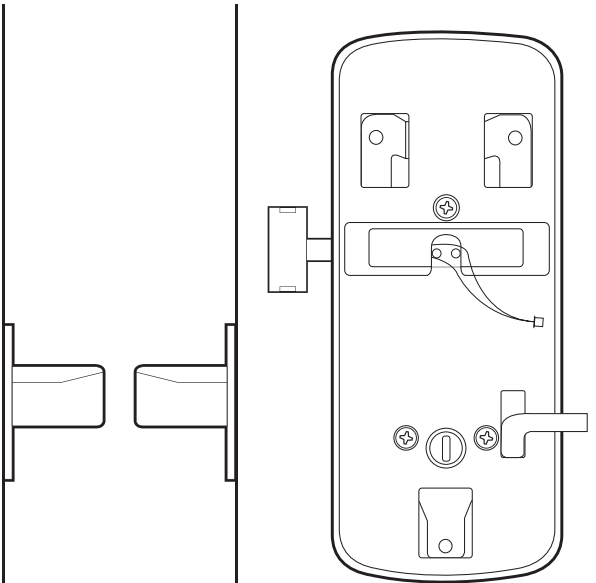

7 Connect Assembly Cable

Connect the sensor cable to the Back Assembly then connect the assembly cable from the Front assembly through the 54mm (2.12") hole to the Back Assembly. Ensure that the wire is installed properly and securely.

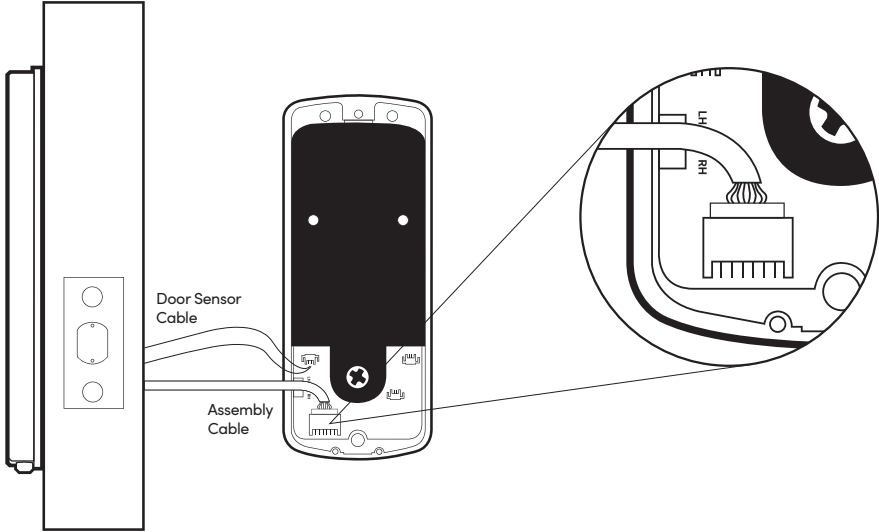

8 Remove Battery Cover from the Back Assembly

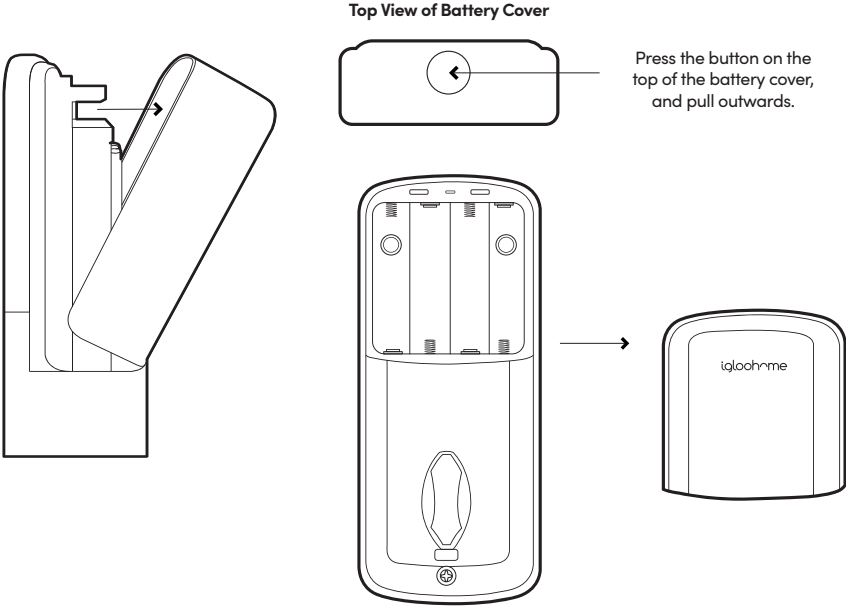

9 Fit Back Assembly to the Door Tailpiece

Ensure thumbturn position is turned to 'unlock' position.

Right-hand Installation

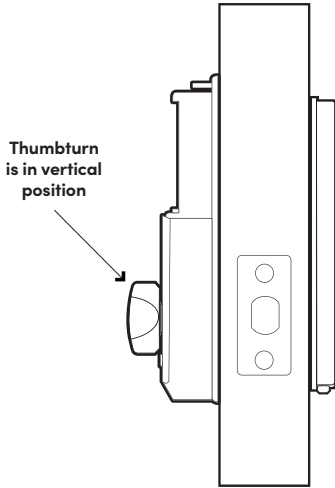

Left-hand Installation

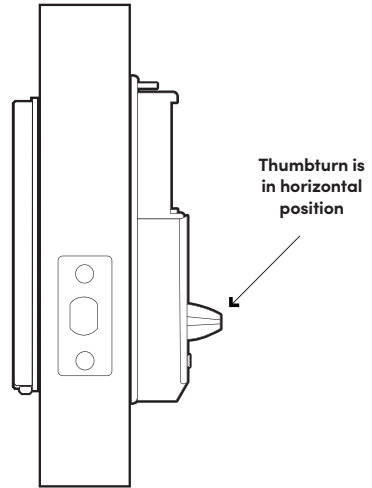

10 Secure the Back Assembly

⚠ Do not overtighten the screws

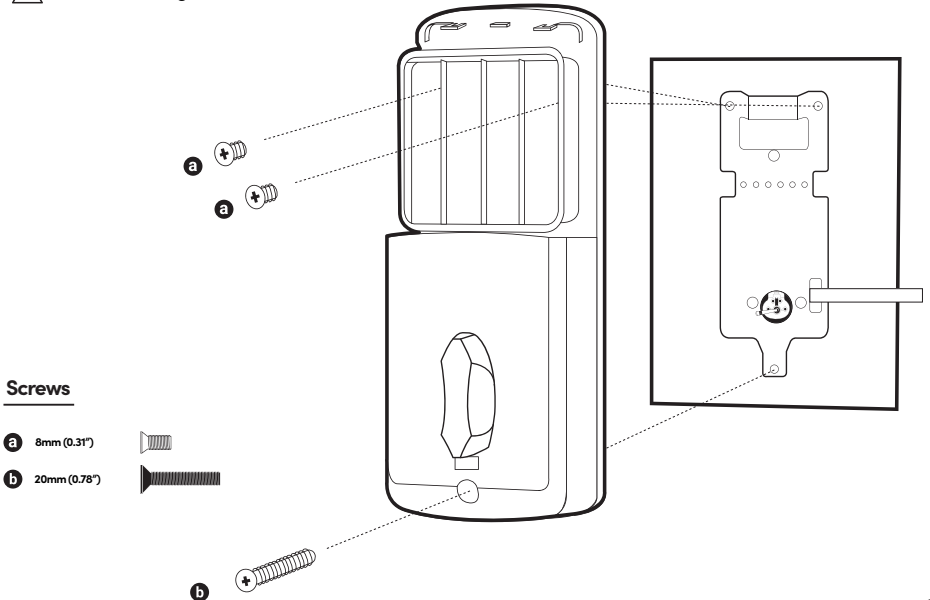

- 11** Insert 4 AA Alkaline Batteries and push the battery case lid inwards to close

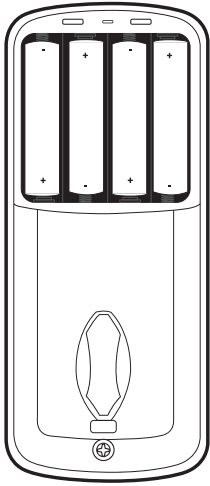

Side View

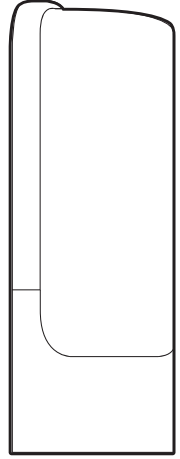
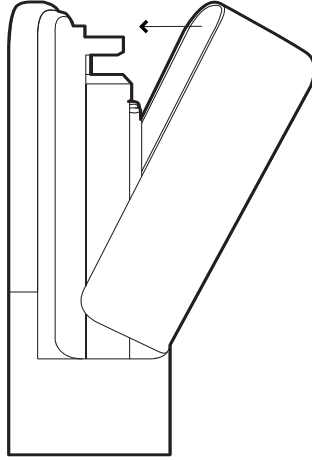

Test Lock

Place hand over your lock to activate touchpad and hold 'Unlock' icon to lock.

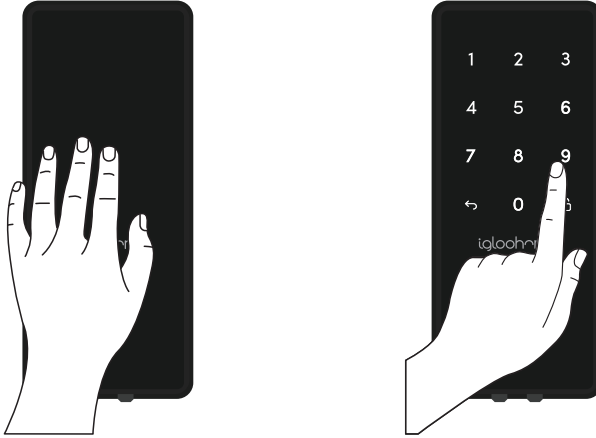

Does your bolt lock?

Yes

Congrats!
Your lock is correctly installed.
Proceed to next steps.

No

Bummer!
Does the bolt lock and unlock
when you turn the thumbturn?

Yes

**Left-Right toggle
incorrectly set**

Troubleshoot: Try Setting the
left-right toggle on your back
assembly to the correct side.
(See Pg. 10)

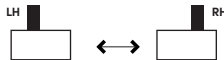

No

**Tailpiece and/or thumbturn
incorrectly set**

Troubleshoot: Disassemble lock
and install it again.

Still experiencing issues?
Go to igloohome.co/support for more help

Prepare the Door Frame

1 Ensure to align the lock to the door frame and mark it down.

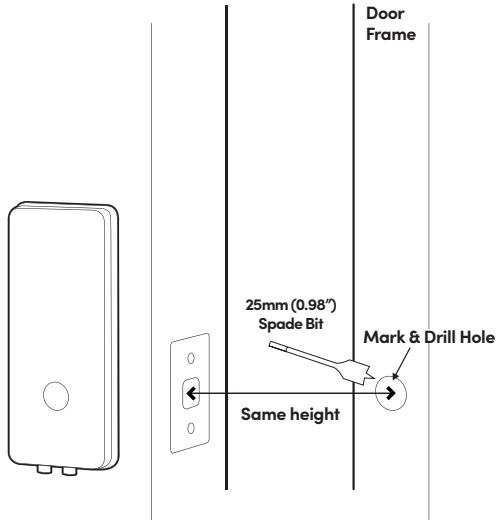

2 Mark out where the bolt tongue locks then drill a corresponding hole on door frame. Chisel to fit the strike plate in as well.

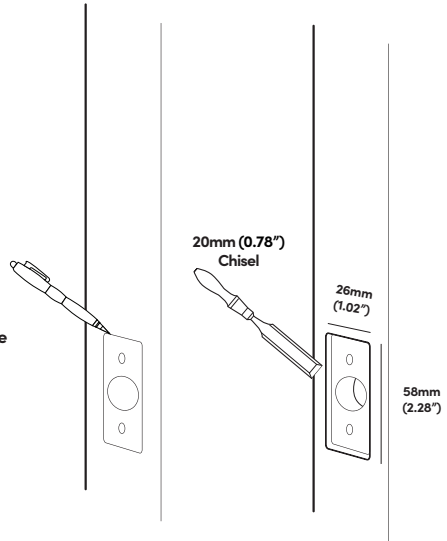

3 Secure strike plate housing and strike plate using 2x 25mm (0.98") wood screws.

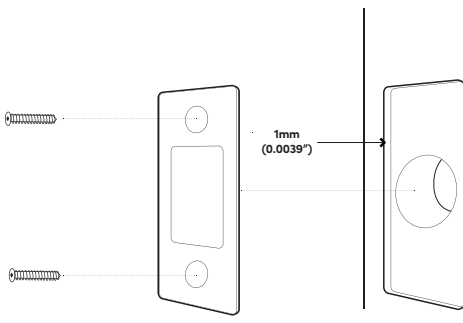

4 Paste the magnet opposite the door sensor.

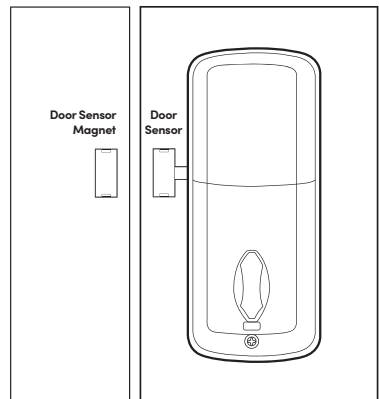

User Guide

Lock Anatomy

Front & Back Assembly

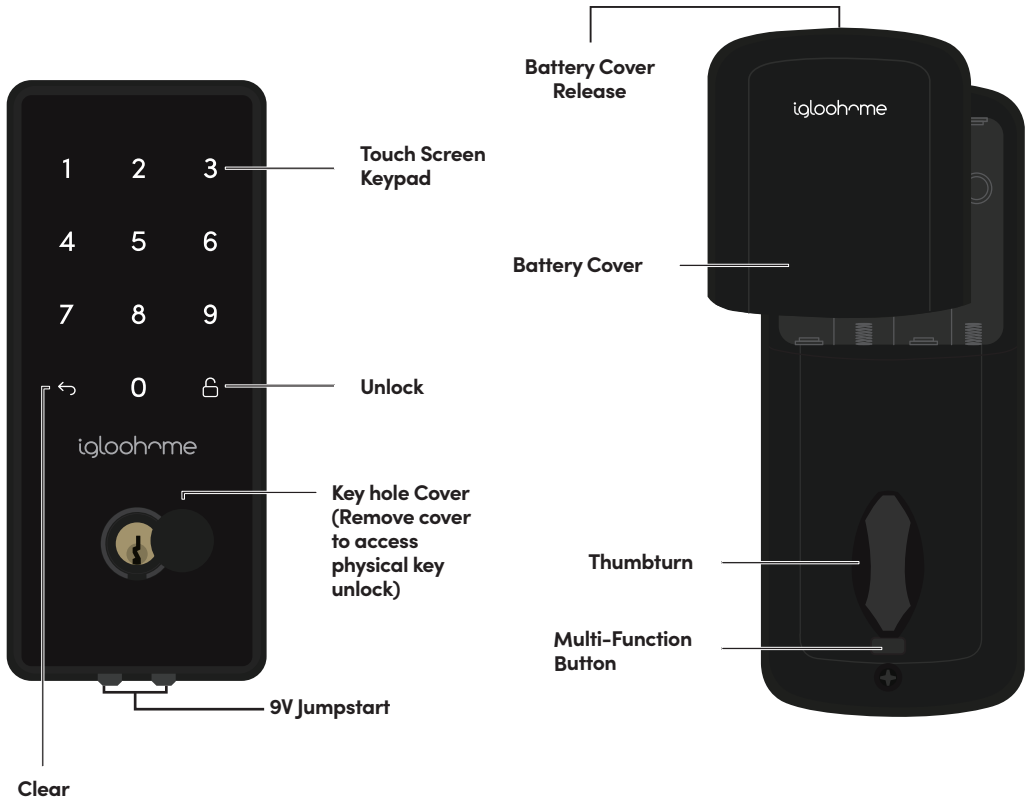

Features

PIN / Bluetooth Unlock



Master PIN Code

The igloohome Deadbolt 2S unlocks with a permanent Master PIN Code.



Master Bluetooth Key

The igloohome Deadbolt 2S unlocks with Bluetooth via the app.



Guest PIN Code

The igloohome mobile app can generate multiple types of User Pin codes, e.g. One-Time, Permanent & Duration.



Guest Bluetooth Key

The igloohome mobile app can generate and share Bluetooth keys (based on duration with guests to unlock the Deadbolt 2S).

Lock



Auto Lock

Heighten security and throw off onlookers by entering random digits before your actual PIN code.



Manual Relock

Hold the 'Unlock' button for 1 second to manually lock the Deadbolt 2S.

Battery



Emergency Jumpstart

Easily jumpstart the lock with a 9V battery if batteries are drained.



Low Battery Alert

An intuitive audio and LED alert will prompt you to change the batteries when it runs low.

Features

Security / Alarms



Security Lockout

Keypad is disabled after several incorrect access attempts to ensure your property is always secure.



Tamper Alarm

The lock will sound an alarm if it is being pried from the door to alert and deter potential tampering attempts.



Privacy Mode

Disable all modes of access except the Master Bluetooth key to prevent unwanted entries into your property.



Obstruction Alarm

The lock will sound an alarm if the bolt tongue cannot be extended or retracted fully to alert the user of any obstructions.



Decoy PIN Code

Heighten security and throw off onlookers by entering random digits before your actual PIN code.

Others



Volume Control

Adjust the volume according to your preference. Select from levels 0 (mute) to 5 (loudest).

Mode of Access

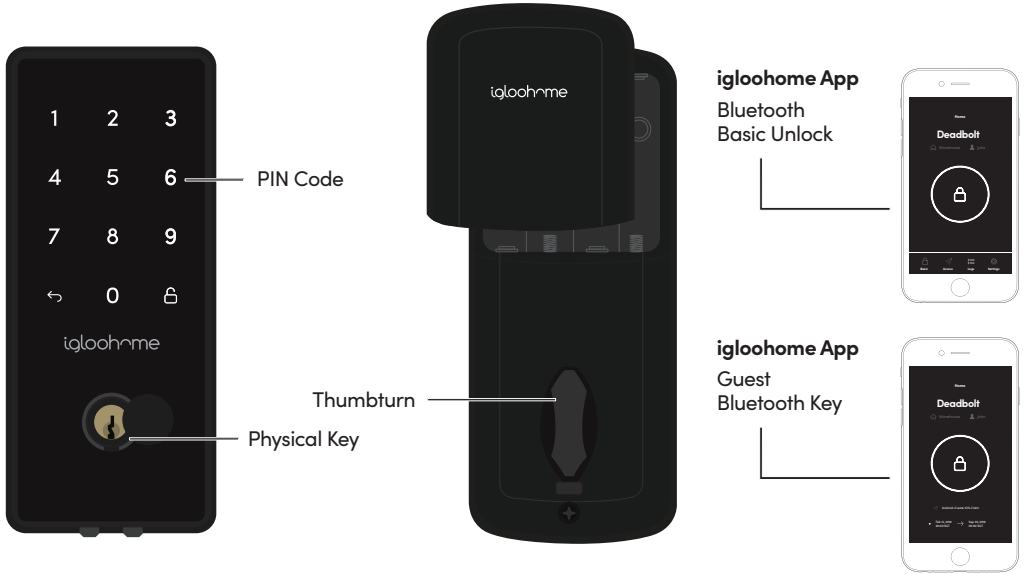

Unlocking



PIN Code

Key in your PIN code and press 'Unlock' icon



Bluetooth Basic Unlock

On your app, tap on the Bluetooth Unlock button and tap on your lock



Thumbturn

Use thumbturn at the back of lock



Guest Bluetooth Key

Refer to page 27



Physical Key

Use the physical key to unlock the door

Locking



'Unlock' Key

Press and hold 🔒



Physical Key

Use the physical key to lock the door



Auto Lock

Works only with the Re-lock Sensor



Thumbturn

Use thumbturn at the back of lock

App Onboarding

1 Download the igloohome app

The mobile app is available for free on the App Store and Google Play Store!

App Store



Google Play



2 Register for an igloohome account

- 1) Launch the igloohome app and tap **[Create new account]**
- 2) Fill in the fields shown on the screen.
- 3) Accept the terms of services and privacy policy.
- 4) Tap **[Create account]**.
- 5) Enter the 6-digit OTP sent to your email address.
- 6) Tap **[Verify]**.
- 7) You now have a verified igloohome account!

If you have forgotten your password,

- 1) Visit the login page and select **[Forgot password?]**
- 2) Enter your registered email address.
- 3) Press **[Submit]**.

You will receive an email with a link and instructions on how to reset your password.

3 Pair the lock to your account

If you're completely new to igloohome:

Test the lock with the Factory PIN code before you begin the pairing process.

1. Wake the lock up by pressing the touchscreen keypad.
2. Tap \leftarrow , then enter 1234567890, followed by \square .
3. The LED indicator on the lock will flash green when it is successfully unlocked.
You will also hear four ascending tones.

a) Create a property to associate your lock with.

1. Tap on \equiv and select **[Add and manage]**.
2. Tap on **[Manage Properties]**.
3. Tap the **[+]** icon.
4. Input the name and region of the property, and tap **[Submit]**.

b) Pair the lock to your account.

1. Tap on \equiv and select **[Add and manage]**.
2. Tap on the **[<]** icon.
3. Tap on **[Add Lock]**.
4. Select the property you created.
5. Follow the instructions on the screen.

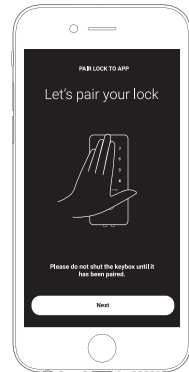

If you're pairing the lock to an existing igloohome account:

1. Tap on \equiv and select **[Add and manage]**.
2. Tap on **[Add Lock]**.
3. Select the property.
4. Follow the instructions on the screen.

4



Change your Master PIN code

The Master PIN code is automatically set after your lock is successfully paired to your igloohome account.

This PIN code is unique to your lock. It will always work as long as the lock is paired to your account.

You can customise this to something that is easier for you.

Before you do this, ensure you are within Bluetooth range of the lock and your Bluetooth function is turned on.

1. On the igloohome mobile app, tap on the  icon.
 2. Tap on **[Master PIN Code]**.
 3. Tap on  and enter a new 7 - 9 digit PIN code.
 4. Enter the new PIN code again.
 5. Tap **[Confirm]**.
-

Managing Access via the app

1 Creating Guest PIN codes

There are **2 ways to create PIN codes** for your guests and family members. Choose from several PIN code validity durations to manage access for different users.

a) If you are away from your property, generate PIN codes on the go with our unique algoPIN™ technology:

1. On the igloohome mobile app, tap on the  icon.
2. Tap on **[+Access]**.
3. Select the access type from the list on the screen.
4. Fill in the required fields.
5. Select **[algoPIN™]**.
6. Tap on **[Create PIN code]**.

b) If you want to create a customised PIN code, you will need to be within Bluetooth range of the lock with your Bluetooth function turned on:

1. On the igloohome mobile app, tap on the  icon.
2. Tap on **[+Access]**.
3. Select the access type from the list on the screen.
4. Fill in the required fields.
5. Select **[Bluetooth]**.
6. Tap on **[Create PIN code]**.

Important:

All PIN codes generated by algoPIN™ technology have activation periods. If they are not used within the period, the PIN codes will be considered invalid.

One-Time & Permanent PIN Codes – 24hrs of being generated

I.e. Generated at 1900hrs today, must be used by 1900hrs tomorrow to activate.

Duration & Recurring PIN Codes – 24hrs from the start date and time of its validity period

I.e. Created for 1900hrs on 1 Jan, must be used from 1900hrs – 2000hrs on 1 Jan to activate.

2

Create Guest Bluetooth Keys

Allow guests and family members to use their smartphones to unlock the door. When you issue a Bluetooth key, you get real-time updates on who has accessed your property.

1. On the igloohome mobile app, tap on the .
2. Tap on **[+Access]**.
3. Select **[Bluetooth Key]**.
4. Fill in the required fields.
5. Tap on **[Create Bluetooth Key]**.
6. Tap on **[Share]**.

Your guest can either scan the unique QR code shown on your screen, or you may share the link via your preferred communication method (Text, Email, WhatsApp, Facebook Messenger etc.) to claim the Bluetooth key.

Your guest will either need to download the igloohome mobile app and register for an account or claim the Bluetooth key with their existing igloohome account.

Important:

All Bluetooth keys must be claimed **within 1 hour** of it being generated. If they are unclaimed within the period, the keys will be considered invalid.

I.e. Generated at 1900hrs today, must be claimed by guest by 2000hrs today.

Bluetooth keys can be revoked by lock owner anytime.

Manage Ecosystem Products via the app

1 Keypad

a) Pair the Keypad to your account

Before linking the Keypad to a lock, you need to add the device to your account:

***Please ensure you are within Bluetooth range of the Keypad and your Bluetooth function is turned on.**

1. Tap on ☰ and select **[Add and manage]**.
2. Select **[Manage Keypads]**.
3. Tap the **[+]** icon located on the top right of the screen, or tap the **[Add Keypad]** button located on the bottom of the screen.
4. Follow the instructions on the screen.

b) Link the Keypad to a lock

***Please ensure you are within Bluetooth range of the lock and Keypad and your Bluetooth function is turned on.**

1. Tap on ☰ and select **[Add and manage]**.
2. Select **[Manage Keypads]**.
3. Select the Key Fob you want to link.
4. Follow the instructions on the screen.



View the full Keypad User Guide

2

Key Fob

a) Pair the Key Fob to your account

Before linking the Key Fob to a lock, you need to add the device to your account:

***Please ensure you are within Bluetooth range of the Key Fob and your Bluetooth function is turned on.**

1. Tap on ☰ and select **[Add and manage]**.
2. Select **[Manage Key Fobs]**.
3. Tap the **[+]** icon located on the top right of the screen, or tap the **[Add Key Fob]** button located on the bottom of the screen.
4. Follow the instructions on the screen.

b) Link the Key Fob to a lock

***Please ensure you are within Bluetooth range of the lock and Key Fob and your Bluetooth function is turned on.**

1. Tap on ☰ and select **[Add and manage]**.
2. Select **[Manage Key Fobs]**.
3. Select the Key Fob you want to link.
4. Follow the instructions on the screen.



View the full Key Fob User Guide

3

Bridge

a) Link the Bridge to a lock or other ecosystem products

1. Tap on ☰ and select **[Add and manage]**.
2. Tap **[Bridges]**.
3. Select the Bridge you want to link your lock to.
4. Tap **[Linked locks and devices]**.
5. Tap the **[+]** icon located on the top right of the screen.
6. Follow the instructions on the screen.



b) Unlink the Bridge from a lock or other ecosystem products





1. Tap on ☰ and select **[Add and manage]**.
2. Tap **[Bridges]**.
3. Select the Bridge you want to unlink from.
4. Tap **[Linked locks and devices]**.
5. Tap  next to the selected lock or ecosystem product you want unlinked.







View the full Bridge User Guide.

Manage Lock Features

<p>Auto Lock</p>	<p>You can configure the duration before Auto Lock is triggered: *Please ensure you are within Bluetooth range of the lock and your Bluetooth function is turned on.</p> <ol style="list-style-type: none"> 1. On your igloohome app, tap on . 2. Select [Auto Lock Timer] 3. Select from the list of preset durations, or customise the number of seconds, or choose to never automatically lock. 4. Tap [Apply]. <p>If you choose to never automatically lock, you may wish to perform a manual relock: Hold the  on the keypad for 3 seconds. The LED indicator will flash green and you'll hear a long beep for successful relocking.</p>												
<p>Security Lockout</p>	<p>You can configure the number of attempts before the Security Lockout mode is enabled: *Please ensure you are within Bluetooth range of the lock and your Bluetooth function is turned on.</p> <ol style="list-style-type: none"> 1. On your igloohome app, tap on . 2. Select [Security Lockout]. 3. Select the number of attempts from 1 to 10, or choose to deactivate this function completely. 4. Tap [Apply]. <p>Once this is set, the lockout will be triggered after you exceed the number of attempts set.</p> <p>Your lock will reject any further unlocking attempts via the same mode you used. You can disable it by trying another valid access mode.</p> <table border="1" data-bbox="266 1011 1015 1332"> <thead> <tr> <th>Triggered</th> <th>Security Alarm</th> <th>Security Lockout</th> </tr> </thead> <tbody> <tr> <td>1st Time</td> <td>30 Sec</td> <td>1 Min</td> </tr> <tr> <td>2nd Time</td> <td>60 Sec</td> <td>5 Min</td> </tr> <tr> <td>3rd and Consecutive Time</td> <td>90 Sec</td> <td>10 Min</td> </tr> </tbody> </table>	Triggered	Security Alarm	Security Lockout	1st Time	30 Sec	1 Min	2nd Time	60 Sec	5 Min	3rd and Consecutive Time	90 Sec	10 Min
Triggered	Security Alarm	Security Lockout											
1st Time	30 Sec	1 Min											
2nd Time	60 Sec	5 Min											
3rd and Consecutive Time	90 Sec	10 Min											
<p>Low Battery Alert</p>	<p>N.A.</p>												

Tamper Alarm	N.A.
Intrusion Alarm	N.A.
Obstruction Alarm	N.A.
Emergency Jumpstart	<ol style="list-style-type: none"> 1. Hold the 9V battery against the jumpstart contact points. 2. The lock will sound off a series of beeps and the keypad will light up. 3. Maintaining the same position with the battery and lock's contact points, enter a valid PIN code, followed by  to unlock.
Decoy PIN Code	<ol style="list-style-type: none"> 1. Key in up to 8 random digits before your actual PIN code, followed by  to unlock.
Privacy Mode	<ol style="list-style-type: none"> 1. Hold the multi-function button on your lock for 3 seconds while it is in 'locked' state i.e. bolt tongue is extended.
Quiet Unlock	<p>To mute audio indicators when unlocking:</p> <ol style="list-style-type: none"> 1. Tap  before entering your PIN code / scanning your RIFD credential / using your fingerprint. <p>You will have to perform the same step every time you wish to activate Quiet Unlock.</p> <p>You will not be able to mute audio indicators if this is performed when the lock is in 'unlocked' state i.e. bolt tongue is retracted.</p>
Volume Control	<p>To configure the volume of your lock:</p> <p>*Please ensure you are within Bluetooth range of the lock and your Bluetooth function is turned on.</p> <ol style="list-style-type: none"> 1. On your igloohome app, tap on . 2. Select [Volume]. 3. Select the volume level from 0 to 5 (softest to loudest). 4. Tap [Apply].

Manage Lock Settings

Delete Lock	<p>To delete a lock from your account, you will need to unpair the device: *Please ensure you are within Bluetooth range of the lock and your Bluetooth function is turned on.</p> <ol style="list-style-type: none">1. On your igloohome app, tap on .2. Select [Delete Lock].3. Follow the instructions shown on the pop-up and tap [Ok].
Delete All PIN Codes	<p>To delete all PIN codes created for a specific lock: *Please ensure you are within Bluetooth range of the lock and your Bluetooth function is turned on.</p> <ol style="list-style-type: none">1. On your igloohome app, tap on .2. Select [Delete All PIN Codes].3. Follow the instructions shown on the pop-up and tap [Ok].
Hard Reset / Unpair	<p>To perform a hard reset:</p> <ol style="list-style-type: none">1. Ensure the lock is in 'unlocked' state i.e. bolt tongue is retracted.2. Delete the lock from your app.3. Press ↶ and the [R] button together for 3 seconds.4. You will hear 3 slow descending tones upon successful reset.
Lock Name	<p>To change the name of your lock:</p> <ol style="list-style-type: none">1. On your igloohome app, tap on .2. Select [Lock Name].3. Enter the new name of your lock.4. Tap [Submit].
Finding your lock's Bluetooth ID	<p>Every lock has a unique Bluetooth ID. Should you need the ID for support purposes, find it by:</p> <ol style="list-style-type: none">1. On your igloohome app, tap on .2. Located on the top of the screen
Sync	<p>We recommend syncing your lock to your account every 3 months for optimal product experience.</p> <p>Syncing the lock to your account helps you stay up-to-date with the lock's battery levels and activity logs.</p> <p>Note: This may take up to 5 minutes depending on how often you sync the lock with your account.</p> <p>To do this:</p> <ol style="list-style-type: none">1. On your igloohome app, tap on .2. Tap the [Sync] button located underneath the battery status.

View Activity Logs

One of the biggest perks of having a smart lock!

You can keep track of all lock activities to ensure you're letting the right ones in.

1. On your igloohome app, tap on .

You will see all PIN code activities from when you last synced the lock with your account, and all Bluetooth key access.

To update all PIN code activity logs:

***Please ensure you are within Bluetooth range of the lock and your Bluetooth function is turned on.**

1. On your igloohome app, tap on .
2. Tap the **[Sync]** button located at the top of the screen.

Note:

This may take up to 5 minutes depending on how often you sync the lock with your account.

Emergency Jumpstart

1 9V Jumpstart Feature

1. Touch and hold the battery contacts against the 9V jumpstart pin on the lock and you will hear a series of beeps and the keypad will light up.
2. While holding the 9V battery to the jumpstart, key in your PIN code on the keypad followed by the 'Unlock' icon

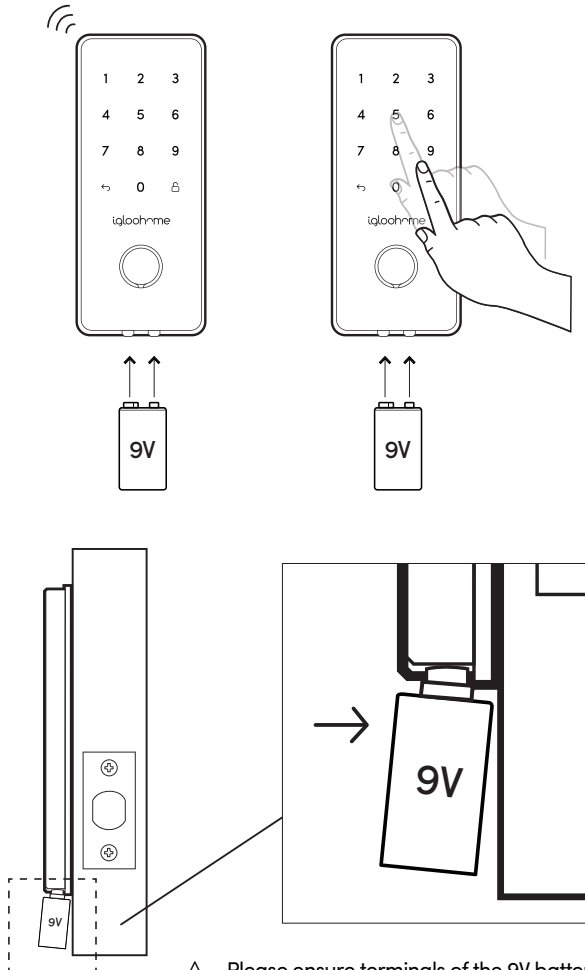



Please ensure terminals of the 9V battery are in contact with the Jump Start contact points of the lock for **2 seconds** to activate your Deadbolt 2S.

Physical Keys

1 Unlocking Orientation

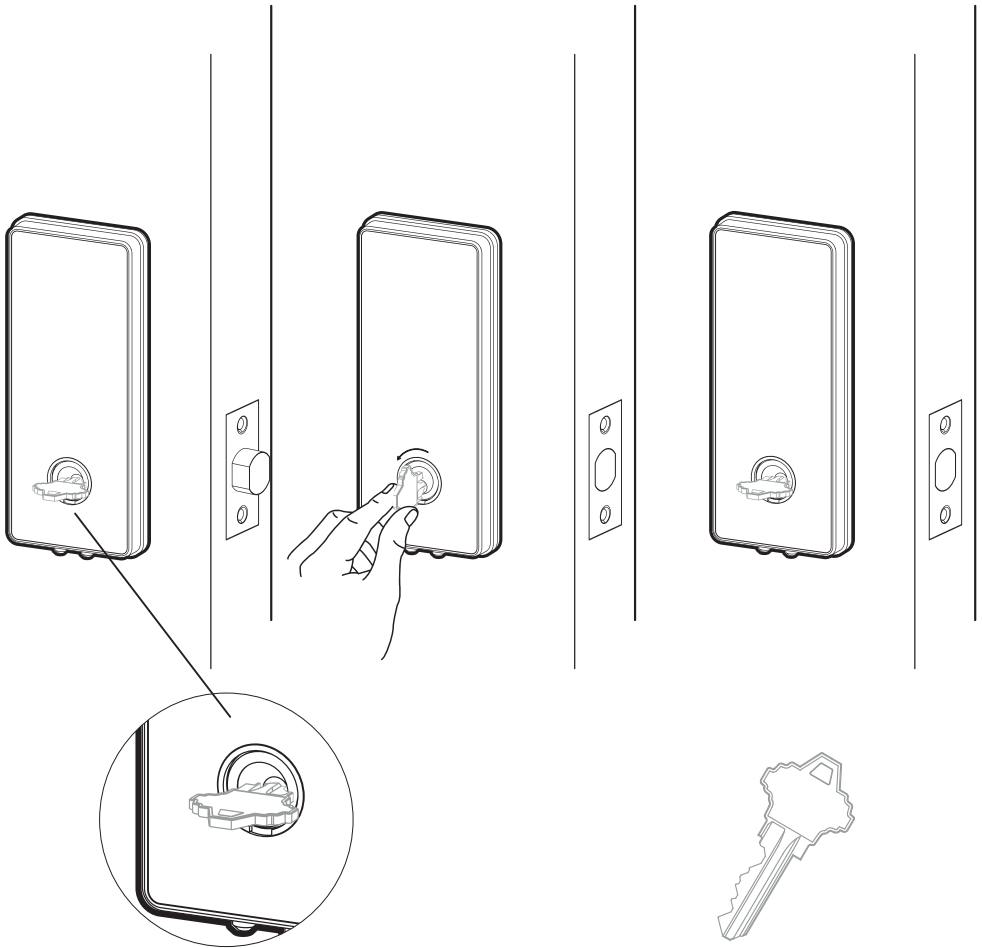
1. Insert the provided physical key horizontally.
2. Turn the key in an anticlockwise direction to unlock.
3. To remove key, turn the key back to clockwise direction.



 Physical keys can only be inserted and removed in this exact same position.

Connect with Airbnb

1 Connect with Airbnb

Airbnb Connect automates the generation of PIN codes for your Airbnb guests based on their approved reservations. It costs USD\$4.99 per month, but is currently on free trial.

Here are the steps to activate Airbnb Connect

Step 1: Connect to your Airbnb

Under **[Account Settings]**, select **[Connect with Airbnb]**

Step 2: Connect to Airbnb listings

Under **[Reservations]**, click the **[Add]** icon to select a home to connect to. Select Airbnb Listing and PIN Time to associate.

Note:

- Emails with PIN code will be sent to the guest between 1 to 48 hours before check-in time (configurable).
- PINs will only be valid between the check-in and check-out times.

Step 3: Change Check-in and Check-out time

Under **[Configuration]**, select **[Manage Homes]** followed by the listing to view or edit its details.

Notes:

- If the access mail has not been sent, changing your check-in/check-out time via the app modifies the start and end time of the PIN codes to be shared with your guest.
- If the access mail has been sent, changing these details will only affect the next reservation.
- Changing these details on the igloohome app does not update the check-in/check-out time on the listing on the Airbnb website.

2 Disconnect Airbnb

Should you prefer to generate PIN codes for your guests manually, you may disconnect your Airbnb listing from the igloohome home listing with the steps below.

1. Under **[Reservations]**, disconnect all the listings (if any).
2. Under **[Account Settings]**, select **[Disconnect with Airbnb]**.

Should you wish to completely disconnect your Airbnb account from your igloohome account, make sure that all your Airbnb listings have been disconnected in the above step, then go to:

Airbnb Host Website > Connected Apps > Select igloohome to disconnect

Audio and LED Indications

Actions	Indications
Bluetooth Connection	'Unlock' icon flashes Blue
Successfully Unlocked	4 fast ascending tones after unlocked
Successfully Locked	1 long beep after Deadbolt 2S is locked
Incorrect PIN	4 short beeps
Deleted PIN	3 sets of 4 short beeps
Obstruction Alarm	6 sets of 4 short beeps
Keypad Disabled Mode Activated	Very long beep
Keypad Disabled Mode Deactivated	2 short beeps
Keypad Security Lockout Alarm	Low-high siren for 30 / 60 / 90 seconds
Keypad Security Lockout Deactivated	2 long beeps
Low Battery Alert	3 fast descending tones when keypad is woken up
Tamper Alarm	Keep long beep
Hard Reset / Unpair	4 slow descending tones

Integrations

SmartThings

This lock is supported on SmartThings. To learn how to use your smart lock with SmartThings visit igloohome.co/integrations/smartthings



[View the full SmartThings FAQ](#)

Troubleshoot

The lock is not responding at all.

- The lock's battery is flat.
- Use an Alkaline 9V Battery to jumpstart the lock and unlock the lock to replace the batteries once you are able to access the battery compartment.

The deadbolt keypad flashes when I activate the keypad.

- If the keypad flashes once, the Security Lockout is triggered.
- If the keypad flashes twice, the Keypad Disabled Mode is activated.
- Refer to page 31 for details.

I tried to use a 9V Battery to jump start the lock but was unable to.

- Please ensure terminals of the 9V Battery are in contact with the jumpstart contact points of the lock for 2 seconds to activate the lock.
- The 9V Battery terminals must be in constant contact with the lock 9V contact pins while unlocking it with PIN code or Bluetooth.

The deadbolt is locking when it is supposed to unlock or unlock when it is supposed to lock.

- Check the LH/RH toggle and ensure that it is at the correct side.
- Refer to page 9 for details.

I have generated my PINs from the app but it doesn't work.

- Do a Bluetooth Unlock or sync and try again.
- Make sure that the generated PIN codes are activated within the activation period before it expires.

Auto lock is not working.

- Check if the Relock Sensor is installed correctly.
- Check if Auto Lock is switched on in the mobile app.
- Check if Keypad Disabled Mode or Passage Mode is deactivated.

My lock gives a 3 descending tones every time I activate the keypad.

- The battery is low in battery.
- Unlock the lock to replace the batteries once you are able to access the battery compartment.

I can't scan the QR sticker as it's worned out.

- Use the spare QR sticker that is provided in the Deadbolt 2S box.

The lock is beeping loudly continuously and none of the functions work.

- The tamper alarm is triggered.
- Please ensure that cable between the front and back body are well connected.

For enquiries go to:
igloohome.co/support